

## Data Sheet

Customer: \_\_\_\_\_

Product: Automotive Grade Thick Film Array Chip Resistor –  
CN..A Series

Size: 0402x4 / 0603x4 / 0201x2(Flat) / 0201x4(Flat)

Issued Date: 24-Sep-20

Edition: REV.A9



VIKING TECH CORPORATION  
光頡科技股份有限公司  
No.70 Guangfu N. Rd., Hukou  
Township, Hsinchu County 303,  
Taiwan

TEL:886-3-5972931  
FAX:886-3-5972935•886-3-5973494  
E-mail:sales@viking.com.tw

VIKING TECH CORPORATION KAOHSIUNG BRANCH  
光頡科技股份有限公司高雄分公司  
No.248-3, Sin-Sheng Rd., Cian-Jhen Dist., Kaohsiung,  
806, Taiwan

TEL:886-7-8217999  
FAX:886-7-8228229  
E-mail:sales@viking.com.tw

VIKING ELECTRONICS (WUXI) CO., LTD.  
光頡電子(無錫)有限公司  
No.22 Xixia Road, Machinery & Industry Park,  
National Hi-Tech Industrial Development Zone  
of Wuxi, Wuxi, Jiangsu Province, China  
Zip Code:214028  
TEL:86-510-85203339  
FAX:86-510-85203667•86-510-85203977  
E-mail:china@viking.com.tw

Produced by (QC)	Checked (QC)	Approved by (QC)	Prepared by (Sales)	Accepted by (Customer)
24-Sep-20	24-Sep-20	24-Sep-20	24-Sep-20	
<b>Susan Huang</b>	<b>J.C. Liu</b>	<b>J.C. Liu</b>		

## Automotive Grade Thick Film Array Chip Resistor

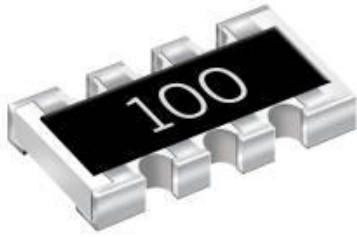

### Scope

- This specification applies to all sizes of rectangular-type fixed chip resistors with Ruthenium-base as material.

### Features

- AEC-Q200 Compliance
- Small size and light weight
- Reduction of assembly costs and matching with placement machines
- Reliability, high quality
- Special construction to prevent sulfuration in a sulfur containing environment
- Suitable for IR reflow soldering
- 100% CCD inspection

### Construction

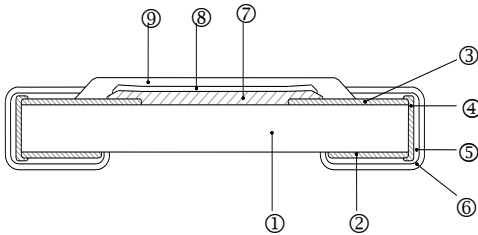

### Applications

- Entertainment
- Computer & Related Products
- Communication Equipment
- Power Equipment
- Measuring Instrument

① Alumina Substrate	④ Edge Electrode	⑦ Resistor Layer
② Bottom Electrode	⑤ Barrier Layer	⑧ Primary Overcoat
③ Top Electrode	⑥ External Electrode	⑨ Secondary Overcoat

### Dimensions

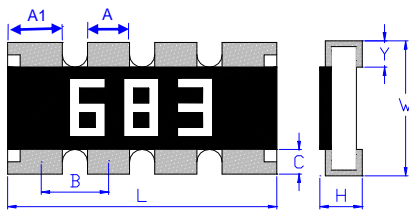

CN-42/43

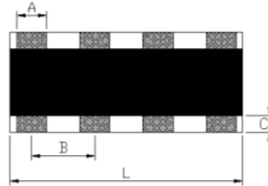

CN-41

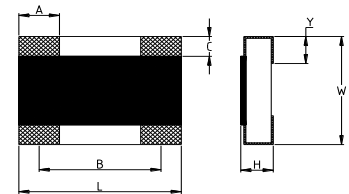

CN-21

Type	Number of Resistors	L (mm)	W (mm)	H (mm)	A (mm)	A1 (mm)	B (mm)	C (mm)	Y (mm)	Weight (g) (1000pcs)
CN-21	2	0.80±0.10	0.60±0.10	0.35±0.10	0.30±0.10	-	0.50±0.10	0.15±0.10	0.15±0.10	0.500
CN-41	4	1.40±0.10	0.60±0.10	0.35±0.10	0.20±0.10	-	0.40±0.10	0.10±0.07	0.15±0.05	0.833
CN-42	4	2.00±0.10	1.00±0.10	0.45±0.10	0.30±0.10	0.40±0.10	0.50±0.05	0.22±0.15	0.22±0.15	2.817
CN-43	4	3.20±0.15	1.60±0.15	0.55±0.10	0.50±0.15	0.65±0.10	0.80±0.05	0.30±0.15	0.30±0.15	8.288

**Part Numbering**

<b>CN-</b>	<b>43</b>	<b>J</b>	<b>A</b>	<b>7</b>	<b>- - - 1 0 R</b>
<b>Product Type</b>	<b>Dimensions</b>	<b>Resistance Tolerance</b>	<b>Function Code</b>	<b>Packaging Code</b>	<b>Resistance</b>
CN- (Array)	21: 0201x2 41: 0201x4 42: 0402x4 43: 0603x4	F: ±1% J: ±5%	A: Automotive Grade	6: 7" Reel 10Kpcs 7: 7" Reel 5Kpcs A: 10" Reel 10Kpcs B: 10" Reel 20Kpcs C: 13" Reel 40Kpcs D: 13" Reel 20Kpcs	--- 1R2: 1.2Ω --- 3K3: 3.3KΩ --- 10K: 10KΩ -- 100K: 100KΩ “-“ to fill up 6 spaces

**Derating Curve**

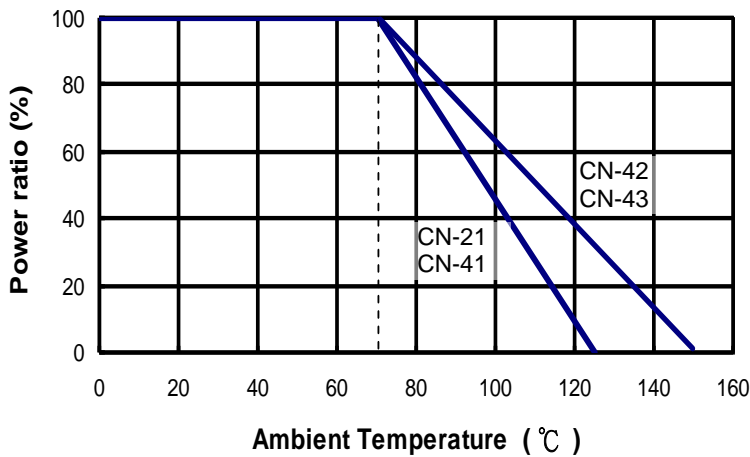

**Standard Electrical Specifications**

Item Type	Power Rating at 70°C Jumper Rated Current	Operating Temp. Range	Max. Operating Voltage	Max. Overload Voltage	Number of Resistors	Resistance Range		TCR (PPM/°C)
						±1%	±5%	
CN-21	1/32W	-55 ~ +125°C	12.5V	25V	2	-	3Ω - 9.1Ω	±300
	Jumper: 0.5A					10Ω - 1MΩ		±200
CN-41	1/32W	-55 ~ +125°C	12.5V	25V	2	-	0Ω (<50mΩ)	-
	Jumper: 0.5A					10Ω - 1MΩ		±200
CN-42	1/16W	-55 ~ +155°C	25V	50V	4	10Ω - 1MΩ	1Ω - 1MΩ	±200
	Jumper: 1A					-	0Ω (<50mΩ)	-
CN-43	1/10W	-55 ~ +155°C	50V	100V	4	10Ω - 1MΩ	1Ω - 1MΩ	±200
	Jumper: 1A					-	0Ω (<50mΩ)	-

Operating Voltage= $\sqrt{P \cdot R}$  or Max. operating voltage listed above, whichever is lower.

Overload Voltage= $2.5 \cdot \sqrt{P \cdot R}$  or Max. overload voltage listed above, whichever is lower.

■ Viking is capable of manufacturing the optional spec based on customer's requirement.

**Equivalent Circuit Diagram**

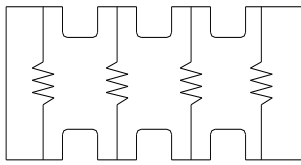

CN-42/43

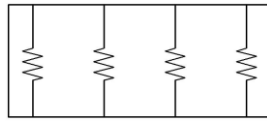

CN-41

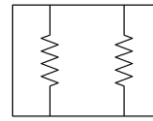

CN-21

**Soldering Condition**

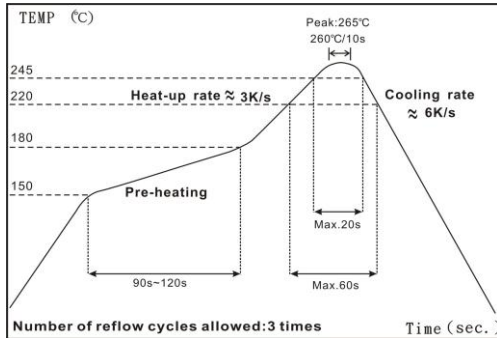

IR Reflow Soldering

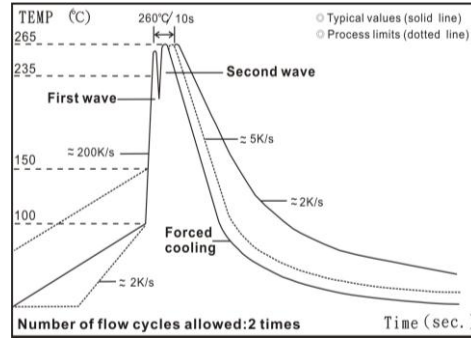

Wave Soldering (Flow Soldering)

- (1) Time of IR reflow soldering at maximum temperature point 260°C : 10s
- (2) Time of wave soldering at maximum temperature point 260°C : 10s
- (3) Time of soldering iron at maximum temperature point 410°C : 5s

**Environmental Characteristics**

Item	Requirement			Test Method
	±1%	±5%	Jumper	
Temperature Coefficient of Resistance (T.C.R.)	As Spec.			<b>JIS-C-5201-1 4.8</b> <b>IEC-60115-1 4.8</b> At 25°C/-55°C and 25°C/+125°C, 25°C is the reference temperature
Short Time Overload	±(1.0%+0.05Ω)	±(2.0%+0.05Ω)	<50mΩ	<b>JIS-C-5201-1 4.13</b> <b>IEC-60115-1 4.13</b> RCWV*2.5 or Max. Overload Voltage whichever is lower for 5 seconds
Insulation Resistance	≥10G			<b>JIS-C-5201-1 4.6</b> <b>IEC-60115-1 4.6</b> Max. Overload Voltage for 1 minute
Operational Life	±(2.0%+0.10Ω)	±(3.0%+0.10Ω)	<100mΩ	<b>MIL-STD-202 Method 108</b> Condition D Steady State TA=125°C at derated power. Measurement at 24±4 hours after test conclusion.
Biased Humidity	±(2.0%+0.10Ω)	±(3.0%+0.10Ω)	<100mΩ	<b>MIL-STD-202 Method 103</b> 1000 hrs 85°C/85%RH 10% of operating power
High Temperature Exposure	±(1.0%+0.05Ω)	±(1.5%+0.10Ω) CN-21/41: ±(3.0%+0.10Ω)	<50mΩ CN-21/41: <100mΩ	<b>MIL-STD-202 Method 108</b> at +125/+155°C for 1000 hrs

Item	Requirement			Test Method
	±1%	±5%	Jumper	
Board Flex	±(1.0%+0.05Ω)	±(1.0%+0.05Ω)	<50mΩ	<b>AEC-Q200-005</b> Bending once for 60 seconds with 3mm
Solderability	95% min. coverage			<b>JIS-C-5201-1 4.17</b> <b>IEC-60115-1 4.17</b> <b>J-STD-002</b> 245±5°C for 3 seconds
Resistance to Soldering Heat	±(0.5%+0.05Ω)	±(1.0%+0.05Ω)	<50mΩ	<b>MIL-STD-202 Method 210</b> 260±5°C for 10 seconds
Voltage Proof	No breakdown or flashover			<b>JIS-C-5201-1 4.7</b> <b>IEC-60115-1 4.7</b> 1.42 times Max. Operating Voltage for 1 minute
Leaching	Individual leaching area ≤5% Total leaching area ≤ 10%			<b>JIS-C-5201-1 4.18</b> <b>IEC-60068-2-58 8.2.1</b> 260±5°C for 30 seconds
Temperature Cycling	±(0.5%+0.05Ω)	±(1.5%+0.05Ω)	<50mΩ	<b>JESD22 Method JA-104</b> -55°C to +125°C, 1000 cycles
Mechanical Shock	±(0.25%+0.05Ω)	±(1.0%+0.05Ω)	<50mΩ	<b>MIL-STD-202 Method 213</b> Wave Form: Tolerance for half sine shock pulse. Peak value is 100g's. Normal duration (D) is 6.
Vibration	±(0.5%+0.05Ω)	±(1.0%+0.05Ω)	<50mΩ	<b>MIL-STD-202 Method 204</b> 5 g's for 20 min., 12 cycles each of 3 orientations, 10-2000 Hz
ESD	±(1%+0.05Ω)			<b>AEC-Q200-002</b> Human body, 2KV
Resistance to Solvents	No visible damage on appearance and marking.			<b>MIL-STD-202 Method 215</b> Add Aqueous wash chemical - OKEM Clean or equivalent. Do not use banned solvents.
Terminal Strength	No broken			<b>AEC-Q200-006</b> Force of 1.8kg for 60 seconds.
Flammability	No ignition of the tissue paper or scorching or the pinewood board			<b>UL-94</b> V-0 or V-1 are acceptable. Electrical test not required.
Sulfur Test	△R±1%	△R±5%	<100mΩ	<b>EIA-977 (Condition A)</b> 60±2°C, no power rating for 480 hrs.

RCWV(Rated Continuous Working Voltage)=√(P\*R) or Max. Operating Voltage whichever is lower.

■ **Storage Temperature: 15~28°C; Humidity < 80%RH**

■ **Recommend Land Pattern**

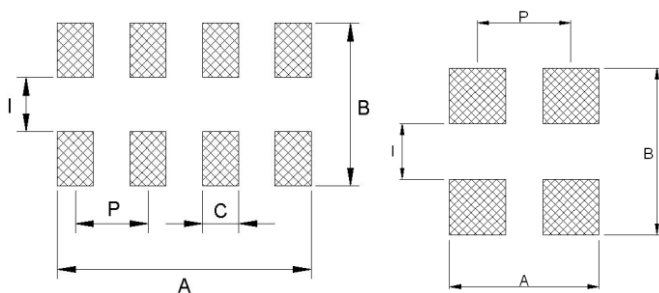

Type	A (mm)	B (mm)	C (mm)	I (mm)	P (mm)
CN-21	0.80	0.90	--	0.30	0.50
CN-41	1.40	0.90	0.20	0.30	0.40
CN-42	2.10	1.80	0.30	0.50	0.50
CN-43	3.10	2.85	0.45	0.80	0.80

**Automotive Grade Thick Film Array Chip Resistor**

**■ Packaging**

Reel Specifications & Packaging Quantity

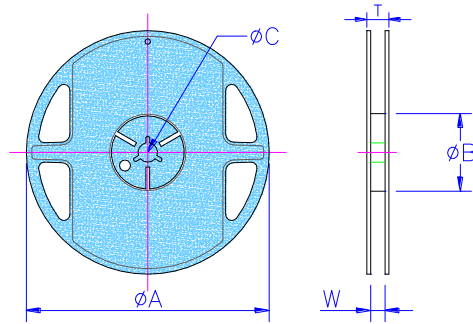

Type	Packaging Quantity		Tape Width	Reel Diameter	ΦA (mm)	ΦB (mm)	ΦC (mm)	W (mm)	T (mm)
CN-21 CN-41	Paper	10K	8mm	7 inch	178.5±1.5	60 <sup>+1/-0</sup>	13.0±0.2	9.0±0.5	12.5±0.5
CN-42	Paper	10K	8mm	7 inch	178.5±1.5	60 <sup>+1/-0</sup>	13.0±0.2	9.0±0.5	12.5±0.5
		20K	8mm	10 inch	254±1.0	100±0.5	13.0±0.2	9.5±0.5	13.5±0.5
		40K	8mm	13 inch	330±1.0	100±0.5	13.0±0.2	9.5±0.5	13.5±0.5
CN-43	Paper	5K	8mm	7 inch	178.5±1.5	60 <sup>+1/-0</sup>	13.0±0.2	9.0±0.5	12.5±0.5
		10K	8mm	10 inch	254±1.0	100±0.5	13.0±0.2	9.5±0.5	13.5±0.5
		20K	8mm	13 inch	330±1.0	100±0.5	13.0±0.2	9.5±0.5	13.5±0.5

Paper Tape Specifications

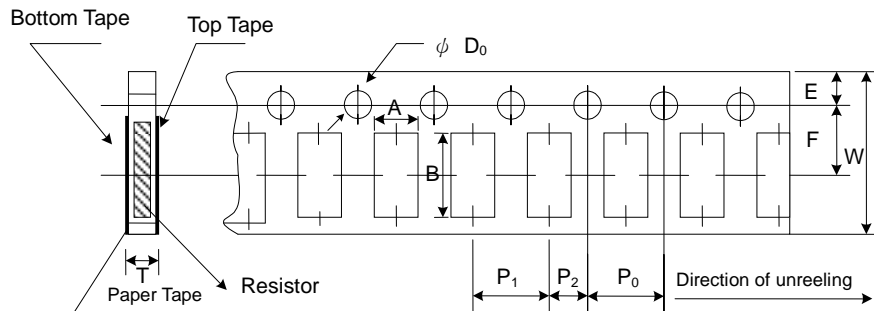

Type	A (mm)	B (mm)	W (mm)	E (mm)	F (mm)	P <sub>0</sub> (mm)	P <sub>1</sub> (mm)	P <sub>2</sub> (mm)	ΦD <sub>0</sub> (mm)	T (mm)
CN-21	0.77±0.05	0.97±0.05	8.0±0.2	1.75±0.1	3.5±0.05	4.0±0.1	2.0±0.05	2.0±0.05	1.50+0.1,-0	0.50±0.1
CN-41	0.77±0.05	1.57±0.05	8.0±0.2	1.75±0.1	3.5±0.05	4.0±0.1	2.0±0.05	2.0±0.05	1.50+0.1,-0	0.50±0.1
CN-42	1.20±0.1	2.20±0.1	8.0±0.2	1.75±0.1	3.5±0.05	4.0±0.1	2.0±0.05	2.0±0.05	1.50+0.1,-0	0.70±0.1
CN-43	1.95±0.1	3.50±0.1	8.0±0.2	1.75±0.1	3.5±0.05	4.0±0.1	4.0±0.05	2.0±0.05	1.50+0.1,-0	0.85±0.1

**■ Marking**

No Marking for CN-21/CN-41

Jumper for all: Letter "0"

1% for CN-42/CN-43: 4 digits marking (non-including E24 series)

Example:

Resistance	102Ω	2.49KΩ	30K1Ω	49.9KΩ	121KΩ
marking	1020	2491	3012	4992	1213

5% for CN-42/CN-43: 3 digits marking in E24

Example: 101=100Ω 102=1KΩ (1<sup>st</sup> and 2<sup>nd</sup> are E24 code and 3<sup>rd</sup> code is multiplier)

E24 code	10	11	12	13	15	16	18	20	22	24	27	30	33	36	39	43	47	51	56	62	68	75	82	91
----------	----	----	----	----	----	----	----	----	----	----	----	----	----	----	----	----	----	----	----	----	----	----	----	----

**REVISION HISTORY**

<b>REVISION</b>	<b>DATE</b>	<b>CHANGE NOTIFICATION</b>	<b>DESCRIPTION</b>
Version A2	Apr 11, 2014		- Recommend Land Pattern updated
Version A3	Apr 30, 2015	-	- Environmental Characteristics updated
Version A4	Jun 15, 2016	-	- Remove Material Description - Modify Storage Temperature - Increase Product Size CN-21 & CN-41
Version A5	Jan 12, 2018	-	- Modify Electrical Specifications (0R)
Version A6	May 20, 2019	-	- Modify TCR Test description - Features added 100% CCD inspection
Version A7	Oct 21, 2019	-	- Increase Sulfur Test
Version A8	Jan 31, 2020	-	- Features added Anti-sulfur characteristics
Version A9	Sep 24, 2020	-	- Add CN-42/CN-43 Dimension A1